

Tepee Sofa

päivitetty 8.5.2023



Without panel



With panel

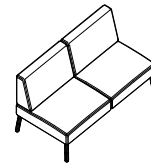

Without panel



With panel

| | Tepee 1-seater sofa S1 | Tepee 2-seater sofa S2 |
|---|--|---|
| | TEPEE SOFA S1 | TEPEE SOFA S2 |
| | ▪ 1-seater sofa for integration or freestanding | ▪ 2-seater sofa for integration or freestanding |
| | Basic price (Euro) according to upholstery price group | |
| 3 | 1578 | 2815 |
| 4 | 1675 | 3011 |

| Backrest finish | | | | |
|-----------------|--------------------------------|---|------|------|
| BA-⑤ | Upholstery | | • | • |
| Seat finish | | | | |
| SE-⑤ | Upholstery | | • | • |
| Leg finish | | | | |
| BC-③/1.007 | Powder-coated steel | Natural beech | • | • |
| BC-③/2.095 | | White stained beech | +25 | +25 |
| BC-③/1.043 | | Black stained beech | | |
| Media 1 | | | | |
| | No media ports | | • | • |
| ⑦-YI001-⑧-B/B | PIX, power socket 230V | 3000 mm cable length, black frame, black port | +103 | +103 |
| ⑦-YI002-⑧-B/B | PIX, double USB charger socket | | +151 | +151 |
| Media 2 | | | | |
| | No media ports | | • | • |
| ⑦-YI001-⑧-B/B | PIX, power socket 230V | 3000 mm cable length, black frame, black port | - | +103 |
| ⑦-YI002-⑧-B/B | PIX, double USB charger socket | | | +151 |
| Panel height | | | | |
| | No panel | | • | - |
| PH2 | 1586 mm height | | - | +574 |

③ – Please specify metal elements finish – see finishes

⑤ – Please specify upholstery colour code from selected price group – see finishes

⑦ – Please specify media port location – see matrix

⑧ – Please specify media port standard: CH13, FR, GB, GE

To complete sofa configuration select options on next pages →

Note: Connectors for connecting sofas with panels to be specified and calculated, see price list.

- Available as standard (included in basic price).

Tepee Sofa

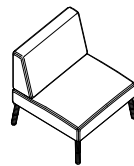

Without panel

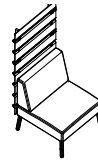

With panel

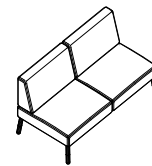

Without panel

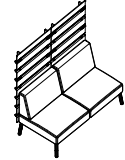

With panel

Tepee 1-seater sofa S1

TEPEE SOFA S1

- 1-seater sofa for integration or freestanding

Tepee 2-seater sofa S2

TEPEE SOFA S2

- 2-seater sofa for integration or freestanding

| Integration | | | | | |
|---------------|---|---------------|-----|---|-----|
| | Module for integration | - | • | - | • |
| IN-F | Freestanding module | - | +60 | - | +60 |
| Panel finish | | | | | |
| DF-FC01/1.007 | Grey felt | Natural beech | - | • | • |
| DF-FC02/1.007 | Light grey felt | | - | ○ | ○ |
| Sample order | TEPEE SOFA S1 (BA-CUZ09 SE-CUZ09 BC-WH/1.007) | | | | |
| | TEPEE SOFA S1 (BA-CUZ09 SE-CUZ09 BC-WH/1.007 A-YI001-FR-B/B PH2 IN-F DF-FC01/1.007) | | | | |

- Available as standard (included in basic price).
- Available as an option (included in basic price).

Tepee Sofa

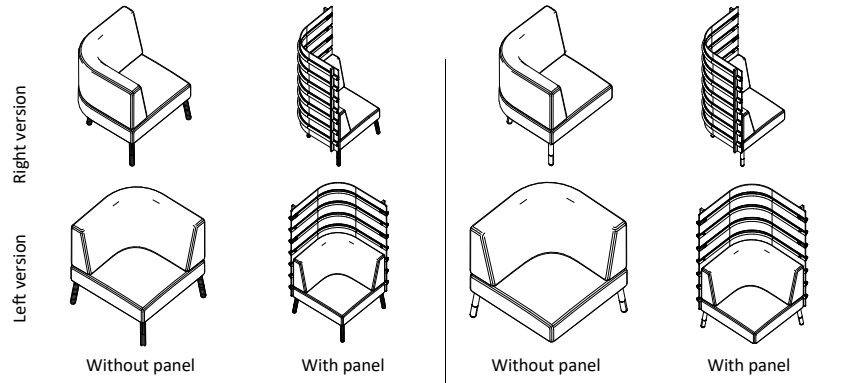

| | Tepee 1-seater sofa C90 | Tepee 1-seater sofa C90D |
|---|---|--|
| | TEPEE SOFA C90 | TEPEE SOFA C90D |
| | <ul style="list-style-type: none"> 1-seater corner sofa 90° for one-sided integration or freestanding | <ul style="list-style-type: none"> 1-seater corner sofa 90° for double-sided integration |
| | Basic price (Euro) according to upholstery price group | |
| 3 | 1870 | 1870 |
| 4 | 1966 | 1966 |

| | | Version | | | | |
|---------------|--------------------------------|---|---|------|----|------|
| V-R | Right | | • | | • | |
| V-L | Left | | ○ | | ○ | |
| | | Backrest finish | | | | |
| BA-⑤ | Upholstery | | • | | • | |
| | | Seat finish | | | | |
| SE-⑤ | Upholstery | | • | | • | |
| | | Leg finish | | | | |
| BC-③/1.007 | Powder-coated steel | Natural beech | | • | • | |
| BC-③/2.095 | | White stained beech | | +25 | 25 | |
| BC-③/1.043 | | Black stained beech | | | | |
| | | Media | | | | |
| | | No media ports | | • | • | |
| ⑦-YI001-⑧-B/B | PIX, power socket 230V | 3000 mm cable length, black frame, black port | | +103 | | |
| ⑦-YI002-⑧-B/B | PIX, double USB charger socket | | | +151 | - | |
| | | Panel height | | | | |
| | | No panel | • | - | • | - |
| PH2 | 1586 mm height | | | +686 | | +686 |

③ – Please specify metal elements finish – see [finishes](#)

⑤ – Please specify upholstery colour code from selected price group – see [finishes](#)

⑦ – Please specify media port location – see [matrix](#)

⑧ – Please specify media port standard: CH13, FR, GB, GE

To complete sofa configuration select options on next pages →

Note: Connectors for connecting sofas with panels to be specified and calculated, see [price list](#).





- Available as standard (included in basic price).
- Available as an option (included in basic price).

PRICE GROUP 3: Silvertex
PRICE GROUP 4: Blazer, Synergy

| | | TEPEE SOFA C90 | | TEPEE SOFA C90D | |
|------------------------|--|----------------|-----|-----------------|---|
| Integration | | | | | |
| Module for integration | | - | ● | - | ● |
| IN-F | Freestanding module | - | +60 | - | - |
| Panel finish | | | | | |
| DF-FC01/1.007 | Grey felt | Natural beech | - | ● | ● |
| DF-FC02/1.007 | Light grey felt | | - | ○ | ○ |
| Sample order | TEPEE SOFA C90 (V-R BA-CUZ09 SE-CUZ09 BC-WH/1.007) | | | | |
| | TEPEE SOFA C90 (V-R BA-CUZ09 SE-CUZ09 BC-WH/1.007 A-YI001-FR-B/B PH2 IN-F DF-FC01/1.007) | | | | |

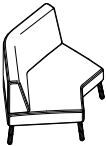
- Available as standard (included in basic price).
- Available as an option (included in basic price).

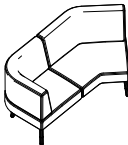
Tepee Sofa

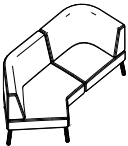
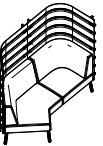
| | | | | | |
|---|--|---|--|---|---|
| |  |  | Right version |  |  |
| | Without panel | With panel | Left version |  |  |
| | Tepee 1-seater sofa C135 | | Tepee 2-seater sofa C135+90 | | |
| | TEPEE SOFA C135 | | TEPEE SOFA C135+90 | | |
| | <ul style="list-style-type: none"> 1-seater corner sofa 135° for integration or freestanding | | <ul style="list-style-type: none"> 2-seater corner sofa 135° + 90° for one-sided integration or freestanding | | |
| | Basic price (Euro) according to upholstery price group | | | | |
| 3 | 2379 | | 4040 | | |
| 4 | 2473 | | 4232 | | |

| Version | | | | | | |
|-----------------|--------------------------------|---|------|-------|------|--|
| V-R | Right | - | | • | | |
| V-L | Left | - | | ○ | | |
| Backrest finish | | | | | | |
| BA-⑤ | Upholstery | • | | • | | |
| Seat finish | | | | | | |
| SE-⑤ | Upholstery | • | | • | | |
| Leg finish | | | | | | |
| BC-③/1.007 | Powder-coated steel | Natural beech | • | | • | |
| BC-③/2.095 | | White stained beech | +25 | | +33 | |
| BC-③/1.043 | | Black stained beech | | | | |
| Media 1 | | | | | | |
| No media ports | | • | | • | | |
| ⑦-YI001-⑧-B/B | PIX, power socket 230V | 3000 mm cable length, black frame, black port | +103 | | +103 | |
| ⑦-YI002-⑧-B/B | PIX, double USB charger socket | | +151 | | +151 | |
| Media 2 | | | | | | |
| No media ports | | • | | • | | |
| ⑦-YI001-⑧-B/B | PIX, power socket 230V | 3000 mm cable length, black frame, black port | - | | +103 | |
| ⑦-YI002-⑧-B/B | PIX, double USB charger socket | | | | +151 | |
| Panel height | | | | | | |
| No panel | | • | | - | | |
| PH2 | 1586 mm height | - | | +701 | | |
| | | • | | - | | |
| | | - | | +1209 | | |

③ – Please specify metal elements finish – see [finishes](#)

⑤ – Please specify upholstery colour code from selected price group – see [finishes](#)

⑦ – Please specify media port location – see [matrix](#)

⑧ – Please specify media port standard: CH13, FR, GB, GE

To complete sofa configuration select options on next pages →

• Available as standard (included in basic price).

○ Available as an option (included in basic price).

Note: Connectors for connecting sofas with panels to be specified and calculated, see [price list](#).

PRICE GROUP 3: Silvertex
PRICE GROUP 4: Blazer, Synergy

| | | TEPEE SOFA C135 | | TEPEE SOFA C135+90 | |
|---------------|---|-----------------|-----|--------------------|-----|
| Integration | | | | | |
| | Module for integration | - | ● | - | ● |
| IN-F | Freestanding module | - | +60 | - | +60 |
| Panel finish | | | | | |
| DF-FC01/1.007 | Grey felt | Natural beech | - | ● | - |
| DF-FC02/1.007 | Light grey felt | | - | ○ | - |
| Sample order | TEPEE SOFA C135+90 (V-R BA-CUZ09 SE-CUZ09 BC-WH/1.007) | | | | |
| | TEPEE SOFA C135+90 (V-R BA-CUZ09 SE-CUZ09 BC-WH/1.007 A-YI001-FR-B/B C-YI001-FR-B/B PH2 IN-F DF-FC01/1.007) | | | | |

- Available as standard (included in basic price).
- Available as an option (included in basic price).

Tepee Sofa

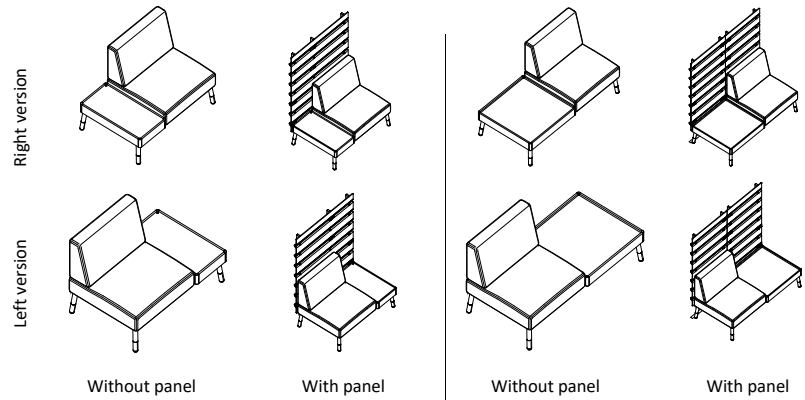

| | Tepee 1-seater sofa STS | Tepee 1-seater sofa STB |
|---|--|--|
| | TEPEE SOFA STS | TEPEE SOFA STB |
| | <ul style="list-style-type: none"> 1-seater sofa with a small table for integration or freestanding table size 375 x 750 mm | <ul style="list-style-type: none"> 1-seater sofa with a large table for integration or freestanding table size 750 x 750 mm |
| | Basic price (Euro) according to upholstery price group | |
| 3 | 2072 | 2408 |
| 4 | 2169 | 2504 |

| Version | | | | | |
|-----------------|--------------------------------|---|---|------|------|
| V-R | Right | | ● | | ● |
| V-L | Left | | ○ | | ○ |
| Backrest finish | | | | | |
| BA-⑤ | Upholstery | | ● | | ● |
| Seat finish | | | | | |
| SE-⑤ | Upholstery | | ● | | ● |
| Leg finish | | | | | |
| BC-③/1.007 | Powder-coated steel | Natural beech | ● | | ● |
| BC-③/2.095 | | White stained beech | | +25 | +25 |
| BC-③/1.043 | | Black stained beech | | | |
| Media (sofa) | | | | | |
| | No media ports | | ● | | ● |
| ⑦-YI001-⑧-B/B | PIX, power socket 230V | 3000 mm cable length, black frame, black port | | +103 | +103 |
| ⑦-YI002-⑧-B/B | PIX, double USB charger socket | | | +151 | +151 |
| Panel height | | | | | |
| | No panel | | ● | - | ● |
| PH2 | 1586 mm height | | - | +867 | - |
| Integration | | | | | |
| | Module for integration | | - | ● | - |

③ – Please specify metal elements finish – see [finishes](#)

⑤ – Please specify upholstery colour code from selected price group – see [finishes](#)

⑦ – Please specify media port location – see [matrix](#)

⑧ – Please specify media port standard: CH13, FR, GB, GE

To complete sofa configuration select options on next pages →

Note: Connectors for connecting sofas with panels to be specified and calculated, see [price list](#).

- Available as standard (included in basic price).
- Available as an option (included in basic price).

| | | | TEPEE SOFA STS | | TEPEE SOFA STB | |
|-----------------------|--|--|----------------|---|----------------|---|
| Panel finish | | | | | | |
| DF-FC01/1.007 | Grey felt | Natural beech | - | • | - | • |
| DF-FC02/1.007 | Light grey felt | | | ○ | | ○ |
| Table top/edge finish | | | | | | |
| TF-①/1.007 | Melamine faced chipboard (MFC) | Natural beech | • | | • | |
| Media (table top) | | | | | | |
| No media ports | | | • | | • | |
| YB001-⑧-W/G | PLUTO, triple power socket 230V | 1500 mm cable length, white frame, grey port | +525 | | +525 | |
| YB003-⑧-W/G | PLUTO, double power socket 230V, double USB charger socket | | +819 | | +819 | |
| Sample order | TEPEE SOFA STS (V-R BA-CUZ09 SE-CUZ09 BC-WH/1.007 TF-DD/1.007) | | | | | |
| | TEPEE SOFA STS (V-R BA-CUZ09 SE-CUZ09 BC-WH/1.007 A-Y1001-FR-B/B PH2 DF-FC01/1.007 TF-DD/1.007 YB001-FR-W/G) | | | | | |

① – Please specify colour code for MFC, linoleum or laminate – see [finishes](#)

⑧ – Media port standard: CH13, FR, GB, GE

Note: Connectors for connecting sofas with panels to be specified and calculated, see [price list](#).

- Available as standard (included in basic price).

Tepee Sofa

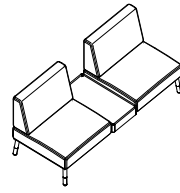

Without panel

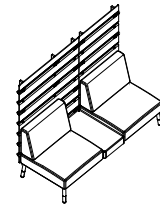

With panel

Tepee 2-seater sofa STC

TEPEE SOFA STC

- table size 375 x 750 mm

Basic price (Euro) according to upholstery price group

| | |
|---|------|
| 3 | 3272 |
| 4 | 3465 |

| | | | |
|---------------|--------------------------------|---|------|
| | Backrest finish | | |
| BA-⑤ | Upholstery | | • |
| | Seat finish | | |
| SE-⑤ | Upholstery | | • |
| | Leg finish | | |
| BC-③/1.007 | Powder-coated steel | Natural beech | • |
| BC-③/2.095 | | White stained beech | +25 |
| BC-③/1.043 | | Black stained beech | |
| | Media 1 (sofa) | | |
| | No media ports | | • |
| ⑦-YI001-⑧-B/B | PIX, power socket 230V | 3000 mm cable length, black frame, black port | +103 |
| ⑦-YI002-⑧-B/B | PIX, double USB charger socket | | +151 |
| | Media 2 (sofa) | | |
| | No media ports | | • |
| ⑦-YI001-⑧-B/B | PIX, power socket 230V | 3000 mm cable length, black frame, black port | +103 |
| ⑦-YI002-⑧-B/B | PIX, double USB charger socket | | +151 |
| | Panel height | | |
| | No panel | | • |
| PH2 | 1586 mm height | | - |
| | Integration | | |
| | Module for integration | | • |
| IN-F | Freestanding module | | - |
| | | | +60 |

- ③ – Please specify metal elements finish – see [finishes](#)
 ⑤ – Please specify upholstery colour code from selected price group – see [finishes](#)
 ⑦ – Please specify media port location – see [matrix](#)
 ⑧ – Please specify media port standard: CH13, FR, GB, GE

To complete sofa configuration select options on next pages →

Note: Connectors for connecting sofas with panels to be specified and calculated, see [price list](#).

- Available as standard (included in basic price).

PRICE GROUP 3: Silvertex
 PRICE GROUP 4: Blazer, Synergy

TEPEE SOFA STC

| Panel finish | | | | |
|-----------------------|--|--|---|------|
| DF-FC01/1.007 | Grey felt | Natural beech | – | • |
| DF-FC02/1.007 | Light grey felt | | | ○ |
| Table top/edge finish | | | | |
| TF-①/1.007 | Melamine faced chipboard (MFC) | Natural beech | | • |
| Media (table top) | | | | |
| No media ports | | | | • |
| YB001-⑧-W/G | PLUTO, triple power socket 230V | 1500 mm cable length, white frame, grey port | | +525 |
| YB003-⑧-W/G | PLUTO, double power socket 230V, double USB charger socket | | | +819 |
| Sample order | TEPEE SOFA STC (BA-CUZ09 SE-CUZ09 BC-WH/1.007 TF-DD/1.007) | | | |
| | TEPEE SOFA STC (BA-CUZ09 SE-CUZ09 BC-WH/1.007 A-YI001-FR-B/B C-YI001-FR-B/B PH2 IN-F DF-FC01/1.007 TF-DD/1.007 YB001-FR-W/G) | | | |

① – Please specify colour code for MFC, linoleum or laminate – see [finishes](#)

⑧ – Media port standard: CH13, FR, GB, GE

Note: Connectors for connecting sofas with panels to be specified and calculated, see [price list](#).

- Available as standard (included in basic price).
- Available as an option (included in basic price).

Tepee Sofa

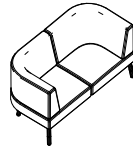

Without panel

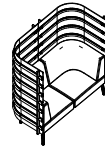

With panel

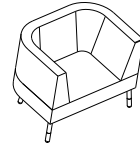

Without panel

| | Tepee 2-seater sofa FS2 | Tepee 1-seater sofa FS1 |
|---|--|-------------------------------|
| | TEPEE SOFA FS2 | TEPEE SOFA FS1 |
| | ▪ 2-seater sofa, freestanding | ▪ 1-seater sofa, freestanding |
| | Basic price (Euro) according to upholstery price group | |
| 3 | 3303 | 2324 |
| 4 | 3315 | 2388 |

| Backrest finish | | | | | |
|-----------------|--------------------------------|---|---|-------|------|
| BA-⑤ | Upholstery | | • | | • |
| Seat finish | | | | | |
| SE-⑤ | Upholstery | | • | | • |
| Leg finish | | | | | |
| BC-③/1.007 | Powder-coated steel | Natural beech | | • | • |
| BC-③/2.095 | | White stained beech | | +25 | +25 |
| BC-③/1.043 | | Black stained beech | | | |
| Media 1 | | | | | |
| No media ports | | | • | | • |
| ⑦-YI001-⑧-B/B | PIX, power socket 230V | 3000 mm cable length, black frame, black port | | +103 | +103 |
| ⑦-YI002-⑧-B/B | PIX, double USB charger socket | | | +151 | +151 |
| Media 2 | | | | | |
| No media ports | | | • | | • |
| ⑦-YI001-⑧-B/B | PIX, power socket 230V | 3000 mm cable length, black frame, black port | | +103 | – |
| ⑦-YI002-⑧-B/B | PIX, double USB charger socket | | | +151 | |
| Panel height | | | | | |
| No panel | | | • | – | • |
| PH2 | 1586 mm height | | – | +1544 | – |
| Panel finish | | | | | |
| DF-FC01/1.007 | Grey felt | Natural beech | | • | – |
| DF-FC02/1.007 | Light grey felt | | – | ○ | |

| | |
|--------------|---|
| Sample order | TEPEE SOFA F2 (BA-CUZ09 SE-CUZ09 BC-WH/1.007) |
| | TEPEE SOFA F2 (BA-CUZ09 SE-CUZ09 BC-WH/1.007 A-YI001-FR-B/B C-YI001-FR-B/B PH2 DF-FC01/1.007) |

- ③ – Please specify metal elements finish – see finishes
 ⑤ – Please specify upholstery colour code from selected price group – see finishes
 ⑦ – Please specify media port location – see matrix
 ⑧ – Please specify media port standard: CH13, FR, GB, GE

Note: Connectors for connecting sofas with panels to be specified and calculated, see price list.

- Available as standard (included in basic price).
 ○ Available as an option (included in basic price).

PRICE GROUP 3: Silvertex
 PRICE GROUP 4: Blazer, Synergy

Tepee sofa accessories – connectors



| | | Tepee external sofa link ESL | Tepee internal sofa link ISL |
|--------------|---------------------------|--|--|
| | | CONNECTOR ESL | CONNECTOR ISL |
| | | <ul style="list-style-type: none"> Wooden external connector for connecting panel in sofa for integration | <ul style="list-style-type: none"> Wooden internal connector for connecting panel in sofa for integration |
| | Number of pieces in a set | Basic price (Euro) | |
| J1 | 1 piece | – | 30 |
| J2 | 2 pieces | 30 | 60 |
| J4 | 4 pieces | 60 | – |
| Sample order | CONNECTOR ESL (J2) | | |

The number of internal connectors needed for assembly of Tepee sofas with panel:

$2 \times (n-1)$ for sofas with panel height 1586 mm,

n – the number of sofas / office panels in a specific arrangement.

Note: Number of connectors to be specified for each separate arrangement. Connectors for freestanding sofas with panels and Tepee Walls included in assembly set.



| | | Tepee sofa link SL |
|--------------|--------------|---|
| | | CONNECTOR SL |
| | | <ul style="list-style-type: none"> Metal connector for connecting sofas for integration 2 pieces in a set |
| | | Basic price (Euro) |
| | | 14 |
| Sample order | CONNECTOR SL | |

The number of internal connectors needed for assembly Tepee sofa:

$2 \times (n - 1 - k)$

n – the number of modules in a specific arrangement,

k – the sum of C90D modules in a specific arrangement.

Note: Number of connectors to be specified for each separate arrangement.

Tepee meeting table

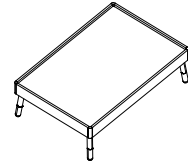
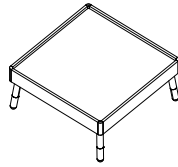

| Tepee small table S | Tepee big table B |
|--|--|
| TEPEE TABLE S | TEPEE TABLE B |
| ▪ Table size: D.750 X W.750 X H.350 mm | ▪ Table size D:750 X W:1125 X H.350 mm |
| Basic price (Euro) | |
| 1040 | 1181 |

| Table top/edge finish | | | | |
|-----------------------|--|--|------|------|
| ①/1.007 | Melamine faced chipboard (MFC) | Natural beech | • | • |
| Media | | | | |
| | No media ports | | • | • |
| YB001-⑧-W/G | PLUTO, triple power socket 230V | 1500 mm cable length, white frame, grey port | +525 | +525 |
| YB003-⑧-W/G | PLUTO, double power socket 230V, double USB charger socket | | +819 | +819 |
| Leg finish | | | | |
| BC-③/1.007 | Powder-coated steel | Natural beech | • | • |
| BC-③/2.09S | | White stained beech | +25 | +25 |
| BC-③/1.043 | | Black stained beech | | |
| Sample order | TEPEE TABLE S (BI/1.007 YB001-FR-W/G BC-WH/1.007) | | | |

- ① – Please specify colour code for MFC, linoleum or laminate – see [finishes](#)
 ③ – Please specify metal elements finish – see [finishes](#)
 ⑧ – Please specify media port standard: CH13, FR, GB, GE

• Available as standard (included in basic price).

Note: Connectors for connecting sofas with panels to be specified and calculated, see [price list](#).

Tepee office wall

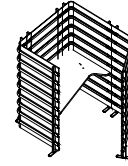
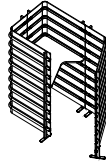

Tepee WORK sit

TEPEE WALL SI

- Workstation with a table top of height 780 mm

| | | | |
|--------------|---------------------------------------|--------------------------|------|
| W•••• | Width (mm) | 1200 | |
| | Table top finish | Basic price (Euro) | |
| TF-① | Melamine faced chipboard (MFC) | 4280 | |
| | Media 1 | | |
| | No media ports/grommets | • | |
| QB-③ | Metal round grommet ø80 mm with brush | +25 | |
| YE004-⑧-SI/B | PIXEL, power socket 230V, double USB | Silver frame, black port | +600 |
| YE004-⑧-SI/W | charger socket, 3000 mm cable length | Silver frame, white port | |
| | Media 2 | | |
| | No media ports/grommets | • | |
| QB-③ | Metal round grommet ø80 mm with brush | | |
| YE004-⑧-SI/B | PIXEL, power socket 230V, double USB | Silver frame, black port | +600 |
| YE004-⑧-SI/W | charger socket, 3000 mm cable length | Silver frame, white port | |

| | |
|--------------|--|
| Sample order | TEPEE WORK SI (W1200 TF-BI PH2 PF-NW-WH DF-FC01/1.007) |
| | TEPEE WORK SI (W1200 TF-BI YE003-FR-SI/W PH2 PF-NW-WH DF-FC01/1.007) |

- ① – Please specify colour code for MFC, linoleum or laminate – see [finishes](#)
 ③ – Please specify metal elements finish – see [finishes](#)
 ⑧ – Please specify media port standard: CH13, FR, GB, GE

- Available as standard (included in basic price).
- Available as an option (included in basic price).

Note: Connectors for connecting sofas with panels to be specified and calculated, see [price list](#).

Note: Integration of Tepee Work SIT workstation only possible with Tepee Walls. Linking connectors included in Tepee Wall assembly set.

Grommets and media ports position: Table top width 1200 mm – left and right

Tepee office wall

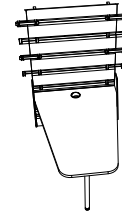

Tepee office wall TV

TEPEE WALL TV

- Straight office wall for integration, dedicated to connect with two sofas F2 with a panel

Basic price (Euro)

870

| Width | | | |
|------------------|---|--|------|
| W800 | 800 mm | | • |
| Panel height | | | |
| PH2 | 1586 mm | | • |
| TV holder | | | |
| | No TV holder | | • |
| HO-TV | TV holder | | +125 |
| Panel finish | | | |
| DF-FC01/1.007 | Grey felt | Natural beech | • |
| DF-FC02/1.007 | Light grey felt | | ○ |
| Table top finish | | | |
| TF-① | Melamine faced chipboard (MFC) | | • |
| Table leg finish | | | |
| BC-③ | Powder-coated steel | | • |
| Media | | | |
| QC-W | Plastic square grommet with round outlet | White | • |
| QC-B | | Black | ○ |
| YB001-⑧-W/G | PLUTO, triple power socket 230V | 1500 mm cable length, white frame, grey port | +525 |
| YB003-⑧-W/G | PLUTO, double power socket 230V, double USB charger socket | | +819 |
| Sample order | TEPEE WALL TV (W800 PH2 DF-FC01/1.007 TF-BI BC-WH) | | |
| | TEPEE WALL TV (W800 PH2 HO-TV DF-FC01/1.007 TF-BI BC-WH YB001-FR-W/G) | | |

① – Please specify MFC colour code – see [finishes](#)

③ – Please specify metal elements finish – see [finishes](#)

⑧ – Please specify media port standard: CH13, FR, GB, GE

Note: Connectors included in Tepee Wall TV assembly set.

- Available as standard (included in basic price).
- Available as an option (included in basic price).

Tepee office wall

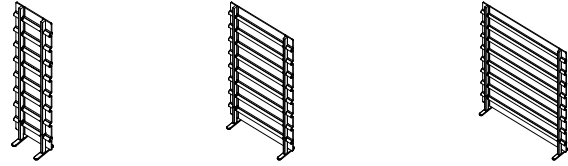

Tepee office wall SW

TEPEE WALL SW

- Straight office panel

| W•••• | Width | 400 | 800 | 1200 | |
|--------------------|---|---------------------|------|------|------|
| Basic price (Euro) | | | | | |
| | | 721 | 839 | 962 | |
| Panel height | | | | | |
| PH2 | 1586 mm height | • | | | |
| Integration | | | | | |
| IN-I | Module for integration – initial module | • | – | • | – |
| IN-M | Module for integration – middle module | +60 | +60 | +60 | +60 |
| IN-E | Module for integration – end module | – | +119 | +119 | +119 |
| IN-F | Freestanding module | – | +60 | +60 | +60 |
| Panel foot | | | | | |
| PF-N-③ | Narrow panel foot | Powder-coated steel | • | | |
| PF-W-③ | Wide panel foot | | +72 | +141 | +72 |
| Panel finish | | | | | |
| DF-FC01/1.007 | Grey felt | Natural beech | • | | |
| DF-FC02/1.007 | Light grey felt | | ○ | | |
| Sample order | TEPEE WALL SW (W400 PH2 IN-E PF-N-WH DF-FC01/1.007) | | | | |

③ – Please specify metal elements finish – see [finishes](#)

Note: Connectors included in Tepee Office Wall assembly set.

- Available as standard (included in basic price).
- Available as an option (included in basic price).

Tepee office wall

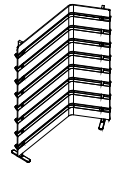
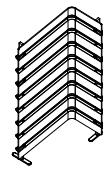
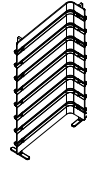

| | | Tepee office wall CW90 | | | | Tepee office wall CW120 | | | |
|---------------|--|---------------------------|------|-----|------|----------------------------|------|-----|------|
| | | TEPEE WALL CW90 | | | | TEPEE WALL CW120 | | | |
| | | ▪ Curved office panel 90° | | | | ▪ Curved office panel 120° | | | |
| W••• | Width | 800 | | | | 800 | | | |
| D••• | Depth | 200 | 400 | | 400 | | | | |
| | | Basic price (Euro) | | | | | | | |
| | | 854 | 928 | | 995 | | | | |
| | | Panel height | | | | | | | |
| PH2 | 1586 mm height | • | | | | • | | | |
| | | Integration | | | | | | | |
| IN-I | Module for integration – initial module | • | – | • | – | • | – | • | – |
| IN-M | Module for integration – middle module | +60 | – | +60 | – | +60 | – | +60 | – |
| IN-E | Module for integration – end module | – | +119 | – | +119 | – | +119 | – | +119 |
| IN-F | Freestanding module | – | +60 | – | +60 | – | +60 | – | +60 |
| | | Panel foot | | | | | | | |
| PF-N-③ | Narrow panel foot | • | | | | • | | | |
| PF-W-③ | Wide panel foot | +72 | +141 | +72 | +141 | +72 | +141 | +72 | +141 |
| | | Panel finish | | | | | | | |
| DF-FC01/1.007 | Grey felt | • | | | | • | | | |
| DF-FC02/1.007 | Light grey felt | ○ | | | | ○ | | | |
| Sample order | TEPEE WALL CW90 (W800 D200 PH2 IN-I PF-N-WH DF-FC01/1.007) | | | | | | | | |

③ – Please specify metal elements finish – see [finishes](#)

Note: Connectors included in Tepee Office Wall assembly set.

- Available as standard (included in basic price).
- Available as an option (included in basic price).

Technical description

Modular line of Tepee sofas and office walls enables to create arrangements that suit office areas of different functionalities. The system is perfect for arranging informal meeting places and relaxation zones as well as reception areas.

Tepee

The line consists of several sofa models that can be arranged freely. Free standing armchair without felt panel (FS1) is the only exception with no extension possibility. Some models are available with a table as an option. The table is fully integrated with the seat and based on the same structure which allows for reducing the number of legs. Tables also available as freestanding modules. Tepee sofas except FS1 model can be equipped with a felt panel available in three heights: 1586 mm which provides possibility of creating „room-in-room“ arrangements.

As an option, individual sofa models and tables can be equipped with electric ports:

Bachmann PIX – electric port dedicated to Tepee sofas available in 2 configurations: 1 × 230V or 2xUSB, cable length 3 m, plastic in black colour only.

PIX 1 – 230V PIX 2 – 2xUSB

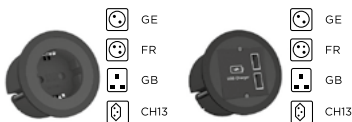

OE Electrics Pluto – electric port dedicated to Tepee tables available in two configurations: 3 × 230V or 2 × 230V + 2xUSB, in standard: CH13, FR, GB, GE, cable length 1,5 m, plastic in white colour only.



Maximum number of media ports and location available in configuration table. Socket type to be specified in the order.

Tepee line is complemented with:

- Tepee Wall
- Tepee Wall TV
- Tepee Work

Sofa construction

Sofas without panel

The structure of sofas is made of metal and wooden frame. Metal frame made of profiles and round tubes as part of legs, powder-coated in Jet black (BL), Traffic white (WT) or “Fashion collection” colours. Wooden solid beech part of legs finished in natural (1.007), black (1.043) or white stain (2.09S). Seat structure made of three-layer cut foam density 40 kg/m³, thickness 9,5–13 cm. Backrest made of cut foam density 21 kg/m³, thickness 9,5 cm.

Sofas with panel

The structure of sofas is made of metal and wooden frame. Metal frame made of profiles and

round tubes as part of legs powder-coated in Jet black (BL), Traffic white (WT) or “Fashion collection” colours. Wooden solid beech part of legs finished in natural (1.007), black (1.043) or white stain (2.09S). Seat structure made of three layer cut foam density 40 kg/m³, thickness 9,5–13 cm. Backrest made of cut foam density 21 kg/m³, thickness 9,5 cm. Sofas are integrated with thermoformed felt panel (100% polyester fiber with reduced fusibility subjected to a needling process) available in 3 heights: 1586 mm and in two colours: dark grey (FC01) and light grey (FC02). The felt panel is fixed to sofa backrest with plywood profiles and additionally stabilized with solid beech wood connectors. Proper number of linking connectors to be ordered separately when sofa to sofa with panel connection is required. Please see section 7 and price list to calculate proper number of connectors.

Freestanding tables

Freestanding table is available with both sides HPL laminated table top and solid beech wooden frame. Metal frame made of profiles and round tubes as part of legs powder-coated in Jet black (BL), Traffic white (WT) or “Fashion collection” colours. Wooden solid beech part of legs finished in natural (1.007), black (1.043) or white stain (2.09S).

Tepee Wall

Tepee Walls are made of thermoformed felt (100% polyester fiber with reduced fusibility subjected to a needling process) with plywood profiles which stabilize the wall and the foot for each profile. Tepee Walls available as straight (SW), curved 90° (CW 90) or 120° (CW 120) versions for integration or freestanding. Tepee Walls available in 3 heights: 1586 mm and in two colours: dark grey (FC01) and light grey (FC02). Felt panels may differ in shade in colour. Tepee Walls available as versions for integration or freestanding.

Tepee Wall for integration

Initial module – this module starts the arrangement for integration. External linking connectors included in the structure of initial module.

Middle module – this module to be connected on both sides with initial module, another middle or end module. Internal linking connectors included in the structure of middle module.

End module – this module always ends the arrangement to be connected with initial or middle module. Internal and external linking connectors included in this module.

Tepee Wall dedicated for integration cannot be a freestanding wall. To connect the walls for integration, internal linking connectors required. Each arrangement ends with external linking connectors. Both internal and external connectors are made of solid beech wood. Initial, end module and any number of middle modules enable to create the arrangement with adequate number of connectors and feet, narrow as standard, wide as an option. Connectors and feet included in the structure of Tepee Walls.

Tepee Wall freestanding module – equipped with proper number of external connectors made of solid beech wood and feet, Feet narrow as standard or wide as an option.

Feet options for Tepee Walls:

Narrow foot – made of metal powder-coated in Jet black (BL), Traffic white (WT) or “Fashion collection” colours.



Wide foot – made of metal powder-coated in Jet black (BL), Traffic white (WT) or “Fashion collection” colours, equipped with Velcro type fixing for soft floors or skidproof rubber for hard floors (both as standard) to increase stability of arrangement.

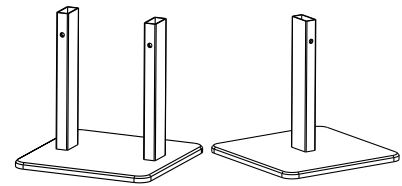

Foot dedicated to connect two Tepee Walls

Foot dedicated to external walls or freestanding walls

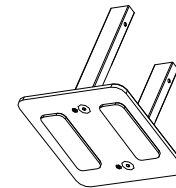

Velcro type fixing for soft floors or skidproof rubber for hard floors

Tepee Walls, both freestanding and for integration are equipped with proper number of internal and external connectors as standard and narrow feet as standard or wide feet as an option.

Tepee Walls with dedicated connectors and feet:

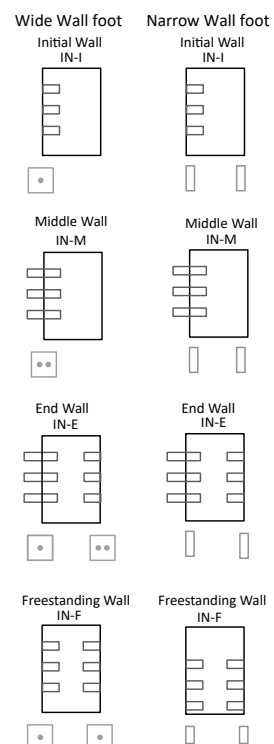

Freestanding Tepee Wall SW with narrow and wide feet:

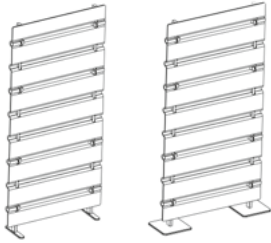

Narrow IN-F Wide IN-F

Tepee Wall TV

Tepee Wall TV dedicated for integration with two FS2 sofas with panels, height 1586 mm only. The Wall 80 × 1586 mm is made of thermoformed felt (100% polyester fiber with reduced fusibility subjected to a needling process) with integrated table. Table top is made of melamine faced chipboard MFC, thickness 25 mm and metal leg powder-coated in Jet black (BL), Traffic white (WT) or “Fashion collection” colours as standard. Media ports or grommets available as an option. Two versions available: without TV holder as standard or with TV set (fixed NBC1 holder) as an option. TV monitor size is max 32”.

Tepee Wall TV with FS2 sofas sample arrangement:



Fixed TV holder for B version.

Tepee Work

Tepee Work workstations dedicated for temporary work consist of Tepee Walls integrated with table top.

Two versions available:

Tepee Work SIT – panel height 1586 mm as standard, table top made of melamine faced chipboard MFC, thickness 25 mm, height 780 mm, width 1200 mm. Further connection with Tepee Wall and sofas with integrated panels available as an option. Grommets, media ports and cable management for table top available as an option.

Tepee Work SIT for integration

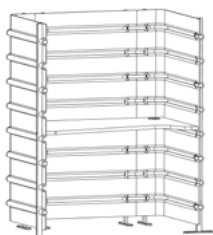

Tepee Work media port:

OE Electrics Pixel – electric port dedicated to Tepee Work table top available in configuration of 1 × 230V + 2XUSB, cable length 3m, plastic in black colour only.

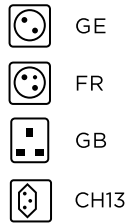
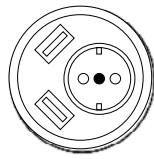

Feet options for Tepee Work:

- narrow foot made of metal powder-coated in Jet black (BL), Traffic white (WT) or “Fashion collection” colours as standard,
- wide foot made of metal powder-coated in Jet black (BL), Traffic white (WT) or “Fashion collection” colours as an option dedicated to external profiles to increase stability of initial walls of the arrangement, additionally equipped with Velcro type fixing for soft floors or skidproof rubber for hard floors (both as standard).

Connectors

Sofa connector – made of metal to connect sofa models with each other. The connectors are not visible when assembled to the frame under the seat.

The number of internal connectors needed for assembly of Tepee sofas:

$$2 \times (n - 1 - k)$$

n – the number of modules in a specific arrangement,

k – the sum of C90D modules in a specific arrangement.

Note: Number of connectors to be specified for each separate arrangement.



Panel connector – made of solid beech wood lacquered to connect panels made of thermoformed felt which stabilizes the panel additionally strengthened with beech plywood profile. The connectors are fixed to the panel with screws included in assembly set.

Types of connectors:

External connector – dedicated to end panels of the arrangements.

The number of connectors needed for assembly: – for sofas with panel height 1586 – 4 pcs.



Internal connector – dedicated to connect panel to panel.

The number of connectors needed for assembly: – for connecting 2 sofas with panel height 1586 mm – 2 pcs



The number of internal connectors needed for assembly Tepee sofas with panel: $2 \times (n-1)$ for sofas with panel height 1586, n – the number of sofas panels in a specific arrangement.

Note: Number of connectors to be specified for each separate arrangement.

Connectors for freestanding sofas with panels and Tepee Walls included in assembly set.

Wire trunking

Horizontal wire trunking – dedicated to Tepee Work made of upholstery fixed directly to table top with plastic brackets. Two widths available: 1200 mm, height 120 mm.

Vertical wire trunking – dedicated to Tepee Work Sit – length 850 mm. It is made of upholstery with zip fixed directly to table top with plastic brackets.

Tepee Work SIT for integration – sample arrangements:

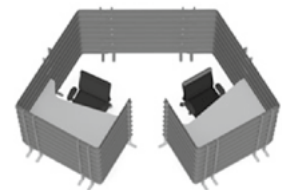

Technical description

Configuration rules

Connection of modules of the same panel height only. Sofa module with table and panel to be integrated with another sofa with panel only.

Tepee sofas with panel configuration



Correct

Tepee Walls configuration

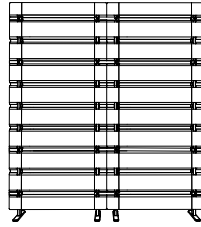

Correct

Tepee sofa module with table and panel to be integrated with another sofa with panel

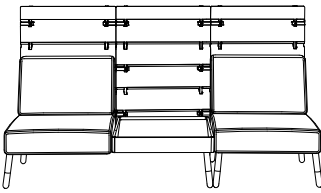

Correct

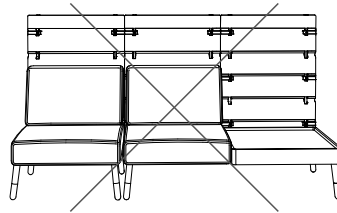





Incorrect



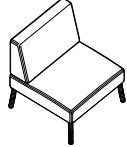

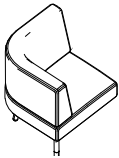
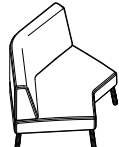
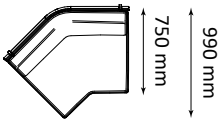
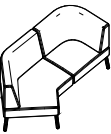
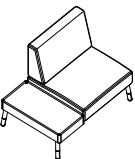
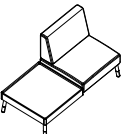

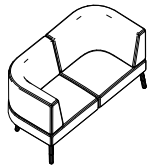
Technical regulations, approvals and quality marks for the chairs (for selected product configurations)

Certificate compliant with norms:
EN 16139; EN 15372; EN 1023-2

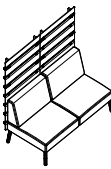
Dimensions

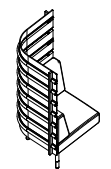
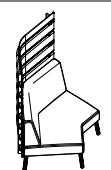
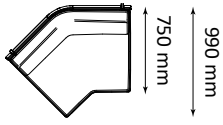

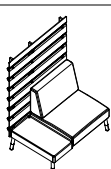
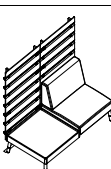
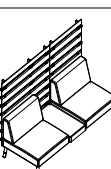

| Model | Drawing | Seat height | Backrest height | Total height | Total width | Total depth | Table top height |
|----------------------------------|---|-------------|-----------------|--------------|-------------|---|------------------|
| FS1 |  | 420 mm | 420 mm | 840 mm | 1026 mm | 734 mm | |
| S1 |  | 420 mm | 420 mm | 840 mm | 750 mm | 750 mm | |
| S2 |  | 420 mm | 420 mm | 840 mm | 1500 mm | 750 mm | |
| C90 right and left version |  | 420 mm | 420 mm | 840 mm | 750 mm | 750 mm | |
| C90D right and left version |  | 420 mm | 420 mm | 840 mm | 750 mm | 750 mm | |
| C 135 |  | 420 mm | 420 mm | 840 mm | 1110 mm |  | |
| C135 + 90 right and left version |  | 420 mm | 420 mm | 840 mm | 1860 mm | 750 mm | |
| STS right and left version |  | 420 mm | 420 mm | 840 mm | 1125 mm | 750 mm | 350 mm |
| STB right and left version |  | 420 mm | 420 mm | 840 mm | 1500 mm | 750 mm | 350 mm |
| STC |  | 420 mm | 420 mm | 840 mm | 1875 mm | 750 mm | 350 mm |
| FS2 |  | 420 mm | 420 mm | 840 mm | 1500 mm | 750 mm | |

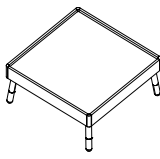
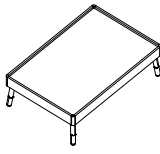
Dimensions

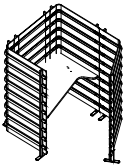
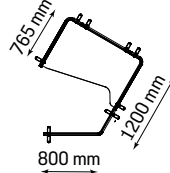
| Model | Drawing | Seat height | Backrest height | Total height with panel | Total width | Total depth | Table top height |
|---|---|-------------|-----------------|-------------------------|-------------|---|------------------|
| S1 with panel |  | 420 mm | 420 mm | 1586 mm | 750 mm | 750 mm | |
| S2 with panel |  | 420 mm | 420 mm | 1586 mm | 1500 mm | 750 mm | |
| C90 with panel right and left version |  | 420 mm | 420 mm | 1586 mm | 750 mm | 750 mm | |
| C90D with panel right and left version |  | 420 mm | 420 mm | 1586 mm | 750 mm | 750 mm | |
| C135 with panel |  | 420 mm | 420 mm | 1586 mm | 1110 mm |  | |
| C135 + 90 with panel right and left version |  | 420 mm | 420 mm | 1586 mm | 1860 mm | 750 mm | |
| STS with panel right and left version |  | 420 mm | 420 mm | 1586 mm | 1125 mm | 750 mm | 350 mm |
| STB with panel right and left version |  | 420 mm | 420 mm | 1586 mm | 1500 mm | 750 mm | 350 mm |
| STC with panel |  | 420 mm | 420 mm | 1586 mm | 1875 mm | 750 mm | 350 mm |
| FS2 with panel |  | 420 mm | 420 mm | 1586 mm | 1500 mm | 750 mm | |

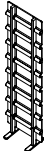
| Tables | | | | |
|---------------------------|---|--------------|-------------|-------------|
| Model | Drawing | Total height | Total width | Total depth |
| Tepee table 750 x 750 |  | 350 mm | 750 mm | 750 mm |
| Tepee table 1125 x 750 |  | 350 mm | 1125 mm | 750 mm |

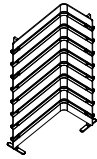
| Work | | | | | | |
|----------------|--|--------------|-------------|-----------------|------------------------|--|
| Model | Drawing | Total height | Total width | Table top width | Working surface height | Wing |
| Tepee Work Sit |  | 1586 mm | 1200 mm | 800 mm | 780 mm |  |

| Office Panels | | | | |
|---------------------------|--|--------------|---------------------|--------------|
| Model | Drawing | Total height | Total width | Total depth |
| Tepee Office Wall SW |  | 1586 mm | 400 / 800 / 1200 mm | — |
| Tepee Office Wall SW CW90 |   | 1586 mm | 800 mm | 200 / 400 mm |
| Tepee Office Wall CW120 |  | 1586 mm | 800 mm | 400 mm |